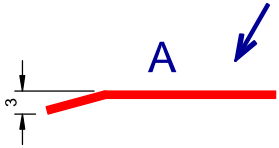
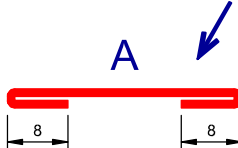
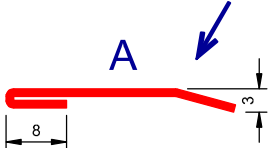
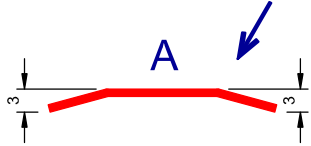
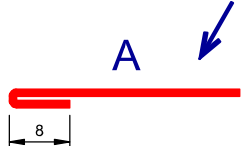
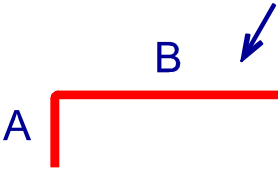
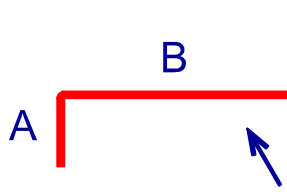
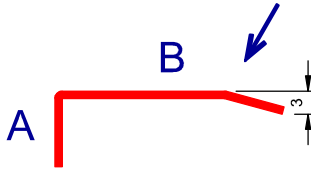
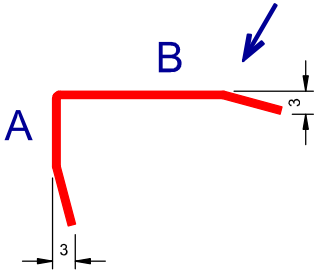
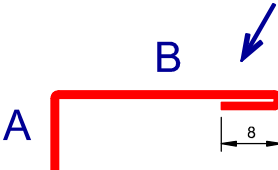
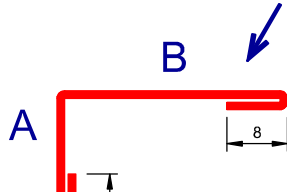
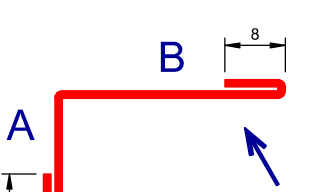
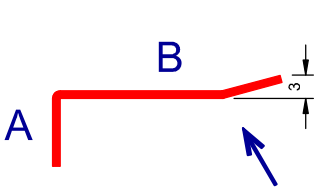
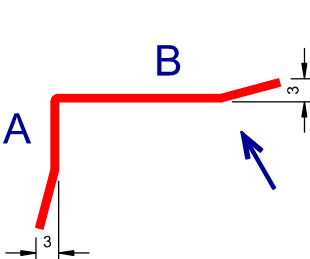
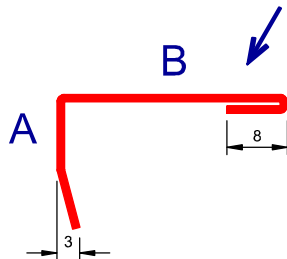
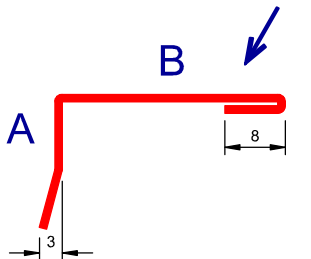
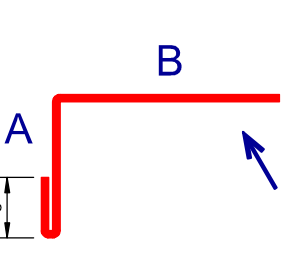
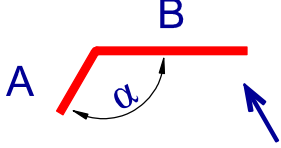
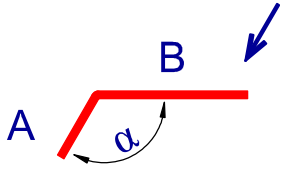
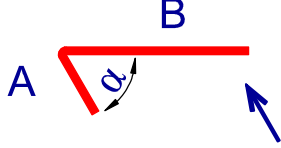
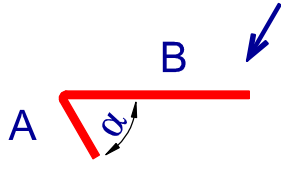
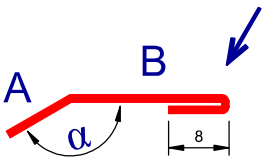
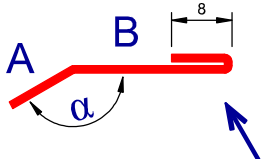
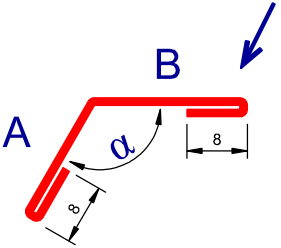
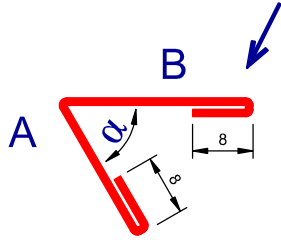
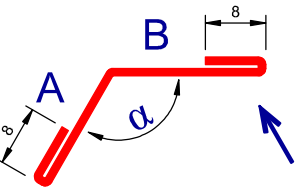
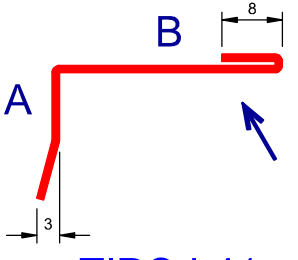
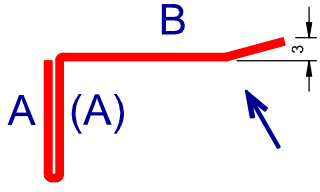
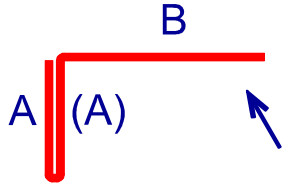
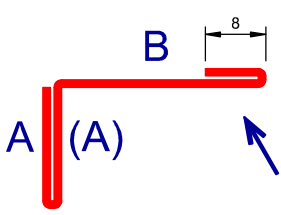
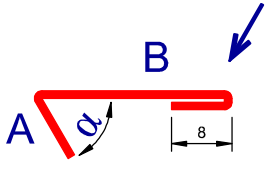
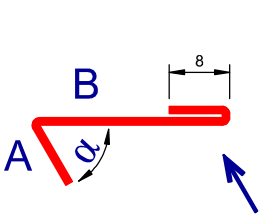
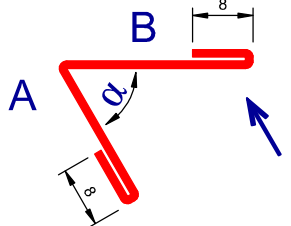
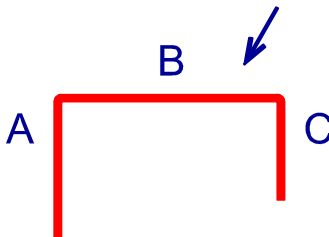
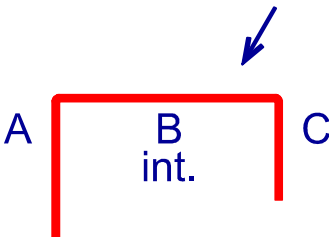
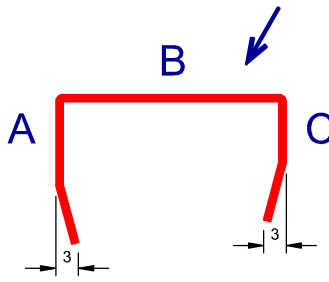
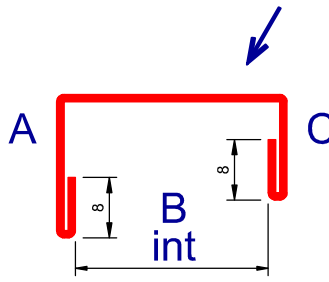

<p>B (ALTEZZA)</p> <p>LAMIERA PIANA A MISURA</p> <p>A (BASE)</p> <p>TIPO LAM10</p>		 <p>TIPO P10</p>	 <p>TIPO P11</p>
 <p>TIPO P14</p>	 <p>TIPO P15</p>	 <p>TIPO P12</p>	 <p>TIPO P13</p>
 <p>TIPO L20</p>	 <p>TIPO L21</p>	 <p>TIPO L22</p>	 <p>TIPO L23</p>
 <p>TIPO L24</p>	 <p>TIPO L25</p>	 <p>TIPO L26</p>	 <p>TIPO L27</p>
 <p>TIPO L28</p>	 <p>TIPO L29</p>	 <p>TIPO L30</p>	 <p>TIPO L31</p>

 <p>TIPO L32</p>	 <p>TIPO L33</p>	 <p>TIPO L34</p>	 <p>TIPO L35</p>
 <p>TIPO L36</p>	 <p>TIPO L37</p>	 <p>TIPO L38</p>	 <p>TIPO L39</p>
 <p>TIPO L40</p>	 <p>TIPO L41</p>	 <p>TIPO L42</p>	 <p>TIPO L43</p>
 <p>TIPO L44</p>	 <p>TIPO L45</p>	 <p>TIPO L46</p>	 <p>TIPO L47</p>
 <p>TIPO U60</p>	 <p>TIPO U61</p>	 <p>TIPO U62</p>	 <p>TIPO U63</p>

<p>TIPO U64</p>	<p>TIPO U65</p>	<p>TIPO U66</p>	<p>TIPO U67</p>
<p>TIPO U68</p>	<p>TIPO U69</p>	<p>TIPO U70</p>	<p>TIPO U71</p>
<p>TIPO U72</p>	<p>TIPO U73</p>	<p>TIPO U74</p>	<p>TIPO U75</p>
<p>TIPO U76</p>	<p>TIPO U77</p>	<p>TIPO Z50</p>	<p>TIPO Z51</p>
<p>TIPO Z52</p>	<p>TIPO Z53</p>	<p>TIPO Z54</p>	<p>TIPO Z55</p>

<p>TIPO Z56</p>	<p>TIPO Z57</p>	<p>TIPO Z58</p>	<p>TIPO Z59</p>
<p>TIPO Z60</p>	<p>TIPO Z61</p>	<p>TIPO Z62</p>	<p>TIPO Z63</p>
<p>TIPO S70</p>	<p>TIPO S71</p>	<p>TIPO S72</p>	<p>TIPO S73</p>
<p>TIPO S74</p>	<p>TIPO S75</p>	<p>TIPO S76</p>	<p>TIPO S77</p>
<p>TIPO S78</p>	<p>TIPO S79</p>	<p>TIPO S80</p>	<p>TIPO S81</p>

<p>TIPO S82</p>	<p>TIPO S83</p>	<p>TIPO S84</p>	<p>TIPO S85</p>
<p>TIPO S86</p>	<p>TIPO S87</p>	<p>TIPO S88</p>	<p>TIPO S89</p>
<p>TIPO S90</p>	<p>TIPO S91</p>	<p>TIPO S92</p>	<p>TIPO C-A10</p>
<p>TIPO C-A1</p>		<p>TIPO C-A2</p>	
<p>TIPO C-A3</p>		<p>TIPO C-A4</p>	

B
(ALTEZZA)

~~LAMIERA
A PUNTA
DI
DIAMANTE~~

A
(BASE)

TIPO LAM11

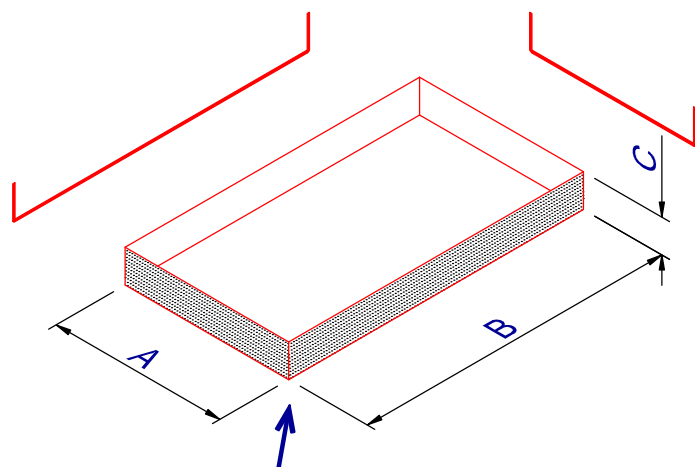

TIPO 4L10

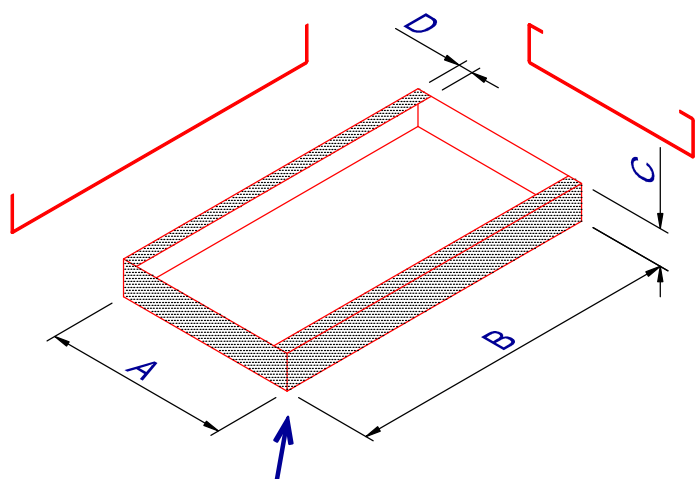

TIPO 4L11

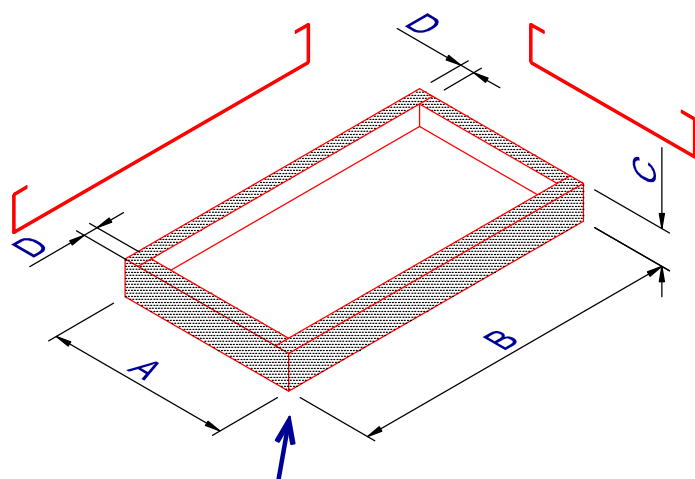

TIPO 4L12

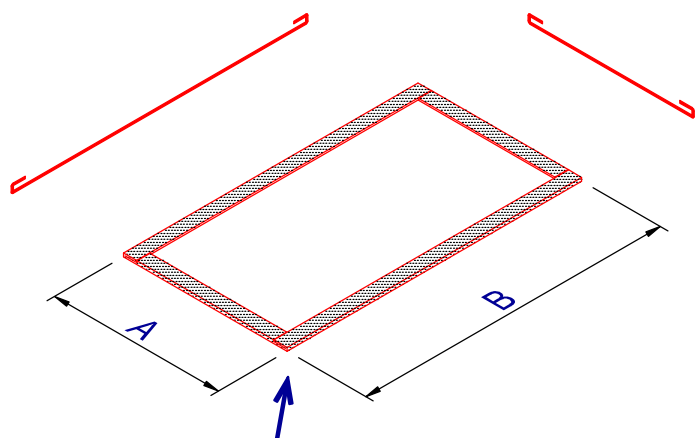

PIEGO SCHIACCIATO DA 8mm SUI 4 LATI

TIPO 4L13

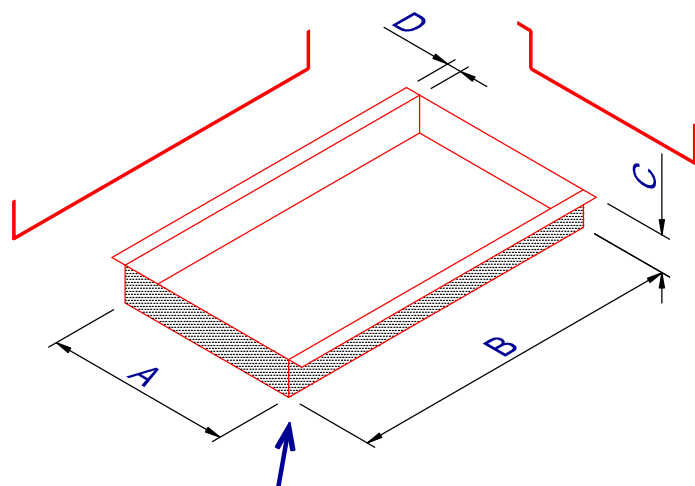

TIPO 4L14

